



PROFESSIONAL LANDSCAPER

YT25E

e-POWER

Instruction Manual



Index

P.1	Index
P.2	Unpacking
P.3	1. Introduction 2. Specifications 3. General Power Tool Safety Warnings
P.4	4. Charging Procedure
P.5	5. Turn On/Off the sprayer
P.6	6. Nozzle & Performance 7. Application
P.7.....	8. Parts Breakdown
P.9	9. Important Return Safety Instructions 10. Statement of Limited Warranty 11. Maintenance
P.10	12. Troubleshooting

Unpacking

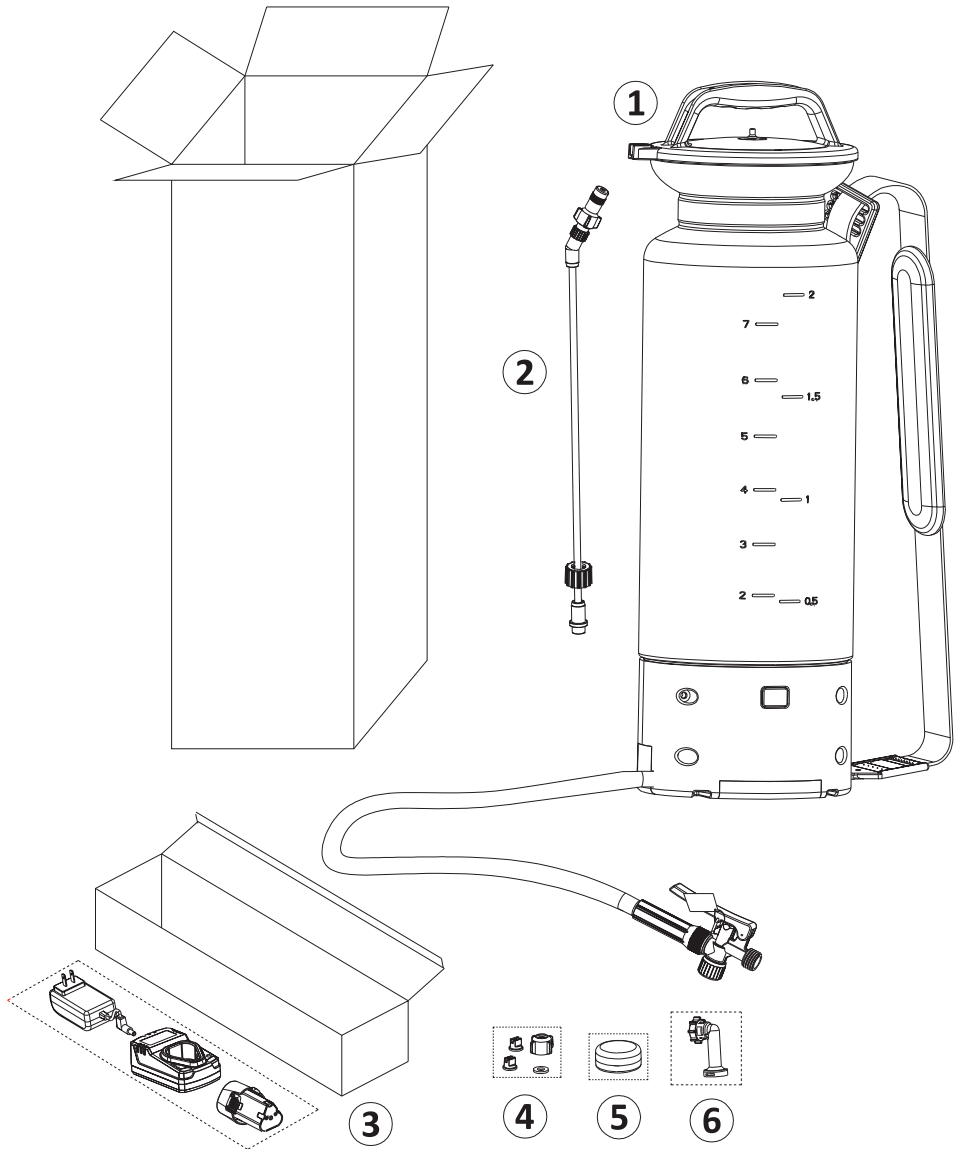

1) Sprayer
4) Nozzles

2) Wand
5) Silicone Grease

3) 12V Charger & Transformer
6) Black Screen Filter

1. Introduction

This manual contains information for the proper assembly, operation and care of your sprayer. Carefully read and follow the instructions contained in this manual before using your sprayer.

2. Specifications

Target Market	Professional
Power	12V Lithium-ion Battery
Capacity US Gallons (Ltr)	2 (7.6)
Dry Weight lbs. (kg)	6.6 (3)
Seals & O-Rings	Viton®
Spray Gun	Sprayers Plus™ with Lock Pin & Filter
Wand	20" Powder Coated Brass
Hose	51" Premium Flex Rubber
Max PSI	30
Working PSI	30
Standard Nozzle	- Brass Adjustable
Fan Nozzle	- Plastic 90° / 110°
Shoulder Strap	Comfort padding / Adjustable Strap
Mouth Opening inch	6.25" QuickFill
Warranty	1 Year (Commercial & Residential)

SAFETY GUIDELINES - DEFINITIONS

It is important for you to read and understand this manual. The information it contains relates to protecting YOUR SAFETY and PREVENTING PROBLEMS. The symbols below are used to help you recognize this information.



DANGER!

Indicates an imminently hazardous situation which, if not avoided will result in death or serious injury.



WARNING!

Indicates a potentially hazardous situation which, if not avoided, could result in death or serious injury.



CAUTION

Indicates a potentially hazardous situation which, if not avoided, may result in minor or moderate injury.

3. General Power Tool Safety Warnings

WARNING:

IMPROPER USE OR FAILURE TO FOLLOW INSTRUCTIONS CAN RESULT IN EXPLOSION CAUSING SERIOUS EYE OR OTHER INJURIES. FOR THE SAFE USE OF THIS, YOU MUST READ AND FOLLOW ALL INSTRUCTIONS.

Do not leave a pressurized sprayer in the hot sun. Heat can cause pressure build up, resulting in possible explosion. Do not store or leave solution in the tank after use. Always wear goggles, gloves, long sleeve shirt, long pants and full foot protection while spraying. Do not attempt to modify this sprayer. Replace parts only with manufacturer's original parts. Never spray flammable, caustic, acidic, chlorine, bleach or other corrosive solutions. Always read and follow manufacturer's instructions before using this sprayer because some chemicals may be hazardous when used with this sprayer.

Handling the brass parts of this product will expose you to a chemical known to the state of California to cause birth defects or other reproductive harm.

Wash hands after handling.

CAUTION:

- **PRE-USE CHECK:** Before each use, check the tightness of the hose to ensure the hose is securely attached to the shut-off assembly. Ensure that all nozzles and wand connections are tight.

- Do not exceed a tank solution temperature of 120°F / 49°C.

NOTE: Residual water may be present in the tank and hose due to quality and performance testing performed on the sprayer.

3.1 Battery Safety

This sprayer is designed to operate with a 12V lithium-ion battery ONLY. Use of any other batteries with the sprayer may cause serious harm or injury to the operator and serious damage to the sprayer.

WARNING:

For safe operation of the charger, read this manual before use. The battery pack does not come fully charged out of the box. Before operating the battery pack and charger, read the safety instructions and follow the charging procedures outlined below.

IMPORTANT SAFETY INSTRUCTIONS FOR BATTERY PACKS

(a) Do not incinerate the battery pack even if it is severely damaged or is completely worn out. The battery pack can explode if exposed to flames or high heat. Toxic fumes and materials are created when battery packs are burned.

(b) Do not charge or use battery in explosive atmospheres, such as in the presence of flammable liquids, gases or dust. Inserting or removing the battery from the charger may ignite the dust or fumes.

(c) If battery contents come into contact with skin, immediately wash area with mild soap and water. If battery liquid gets into the eye, rinse water over the open eye for 15 minutes or until irritation ceases. If medical attention is needed, see a doctor immediately. The battery electrolyte for lithium-ion batteries is composed of a mixture of liquid organic carbonates and lithium salts.

(d) Contents of opened battery cells may cause respiratory irritation. If respiratory irritation is experienced due to exposure, move person to a well-ventilated area immediately. If symptoms persist, seek medical attention.

WARNING:

Burn hazard. Battery liquid may be flammable if exposed to sparks or flames.

- Charge the battery packs only in Sprayers Plus chargers.
- DO NOT splash or immerse in water or other liquids. This may cause premature cell failure.
- DO NOT store or use the tool and battery pack in locations where the temperature may reach or exceed 105°F(40°C) (such as outdoor sheds or metal buildings in the summer season).

Never attempt to open the battery pack for any reason. If battery pack casing is cracked or damaged, do not insert into charger. Do not crush, drop or damage battery pack. Do not use a battery pack or charger that has received a sharp blow, been dropped, run over or damaged in any way. Damaged battery packs should be returned to a service center for recycling.

WARNING:

Fire hazard. Do not store or carry the battery in such a way that metal objects can contact exposed battery terminals. For example, do not place battery in aprons, pockets, toolboxes, product kit boxes, drawers, etc.

To prevent fire risk while transporting batteries, ensure battery terminals do not come in contact with conductive materials such as keys, coins, hand tools and the like. The US Department of Transportation's Hazardous Material Regulations (HMR) prohibits the transport of lithium-ion batteries in commerce or on airplanes (i.e., packed in suitcases and carry-on luggage) UNLESS they have proper short-circuit protection. When transporting individual batteries, make sure that the battery terminals are protected and well insulated from materials that could contact them and cause a short circuit.

NOTE: Lithium-ion batteries should NOT be put in checked baggage.

3.2 Storage Recommendations

The best storage place is one that is cool and dry — away from direct sunlight and excess heat or cold.

Long-term storage will not harm the battery pack or charger.

4. Charging Procedure

Sprayers Plus chargers are designed to charge Sprayers Plus 12V battery packs only.

Charging lights

1. Plug the charger into an appropriate outlet before inserting the battery pack.
2. A (fast) flashing red light indicates that the charger is ready to be used.
3. Insert the battery pack into the charger.
4. An illuminated red light indicates that the battery is being charged.
5. When the illuminated light changes from red to green, the battery is fully charged.
6. A (slow) flashing red light indicates a charging error. Go to dealer for help.

Battery power light

(only works when charger is not plugged into the power outlet)

1. The 3 blue LED lights indicate the battery power.
2. 3 illuminated lights indicate that the battery is fully charged.
3. 1 illuminated light indicates low battery levels.



- 12V Lithium-ion battery (Parts: K7048)
- 12V Charger (Parts: K8002)

LEAVING THE BATTERY IN THE CHARGER

The charger and battery pack can be left connected with the green LED light glowing. The charger will keep the battery pack fresh and fully charged.

4.1 IMPORTANT CHARGING NOTES

- (1) The longest life and best performance can be obtained if the battery pack is charged in an environment where the air temperature is between 65°F and 75°F (18°C-24°). DO NOT charge the battery pack in an environment where the air temperature drops below 40°F (+4.5°C), or rises above +105°F (+40.5°C). Follow these guidelines to prevent serious damage to the battery pack.
- (2) The charger and battery pack may become warm to touch while charging. This is normal and does not indicate a problem. To facilitate the cooling of the battery pack after use, avoid placing the charger or battery pack in a warm environment such as in a metal shed or an uninsulated trailer.
- (3) If the battery pack does not charge properly:
 - a.) Check current at the outlet or receptacle by plugging in a lamp or other appliance.
 - b.) Check to see if outlet or receptacle is connected to a light switch which turns the power off when you turn off the lights.
 - c.) Move charger and battery pack to a location where the surrounding air temperature is between approximately 65°F and 75°F(18°-24°C)
 - d.) If charging problems persist, take the tool, battery pack and charger to your local service center.
- (4) The battery pack should be recharged when it fails to produce sufficient power on jobs that were previously easy to complete. DO NOT CONTINUE with use under these conditions. Follow the charging procedure to recharge the battery. You may also charge a battery used pack when ever you desire with no adverse effect to the battery pack.
- (5) Foreign materials of a conductive nature such as, but not limited to, steel wool, aluminum foil, or any buildup of metallic particles should be kept away from charger cavities. Always unplug the charger from the power supply when there is no battery pack in the cavity. Unplug charger before attempting to clean.
- (6) Do not freeze or immerse charger in water or any other liquid.



WARNING:

Shock hazard. Do not allow any liquid to get inside charger. Never attempt to open the battery pack for any reason. If the plastic housing of the battery pack breaks or cracks, return to a service center for recycling.

POWER BATTERY

Li-ion 12V 2.2Ah/23.76wh

WARNING

To reduce the risk of fire or burns, do not disassemble, crush, puncture or short external contacts.



4.2 INSTALLING AND REMOVING THE BATTERY PACK FROM THE SPRAYER



WARNING:

Make sure switch is in the off position.

To install battery pack:

Insert battery pack into tool until a "click" is heard. Make sure battery pack is fully seated and latched into position.

To remove the battery pack:

Depress the battery release button and pull battery pack out of tool.

- Pull by the plug rather than pulling by the cord when disconnecting charger. This will reduce risk of damage to electric plug and cord.
- Do not use an extension cord unless it is absolutely necessary. Use of an improper extension cord could result in risk of fire, electric shock, or electrocution.
- An extension cord must have adequate wire size (AWG or American Wire Gauge) for safety. The smaller the gauge number of the wire, the greater the capacity of the cable, that is 16 gauge has more capacity than 18 gauge. When using more than one extension to make up the total length, be sure each individual extension cord contains at least the minimum wire size required.
- Do not operate charger with a damaged cord or plug – please have them replaced immediately.
- Do not operate charger if it has received a sharp blow, been dropped, or damaged in any way. Take it to an authorized service center.
- Do not disassemble charger; take it to an authorized service center when service or repair is required. Incorrect reassembly may result in risk of electrocution or fire.
- Disconnect the charger from the outlet before attempting any cleaning. This will reduce the risk of electric shock. Removing the battery pack will not reduce the risk.
- NEVER attempt to connect 2 chargers together.
- The charger is designed to operate on standard household electrical power(120 Volts). Do not attempt to use it on any other voltage.

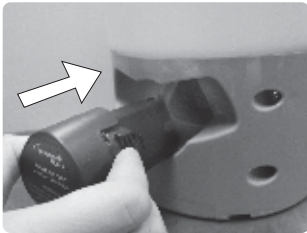

- To install the battery •

Insert the battery into tool until an audible click is heard.



- To remove the battery •

Apply pressure to the trigger on both sides. Release the battery by pulling out from tool.

4.3 IMPORTANT SAFETY INSTRUCTIONS FOR BATTERY CHARGERS

WARNING:

- Shock hazard. Do not allow any liquid to get inside charger.
- Do not attempt to charge the battery pack with any chargers other than the ones included in this manual. The charger and battery pack are specifically designed to work together.
- These chargers are not intended for any uses other than charging rechargeable batteries. Any other uses may result in risk of fire or electrocution.
- Do not expose charger to rain or snow

CAUTION:

When the charger is plugged into the power supply under certain conditions, the charger can be shorted by foreign material. Foreign materials of a conductive nature such as, but not limited to, steel wool, aluminum foil, or any build up of metallic particles should be kept away from charger cavities. Always unplug the charger from the power supply when there is no battery pack in the cavity. Unplug charger before attempting to clean.

5. Turn On/Off the sprayer

NOTE: Before starting to spray, retighten the hose clamps to avoid contamination of the operator and of the environment.

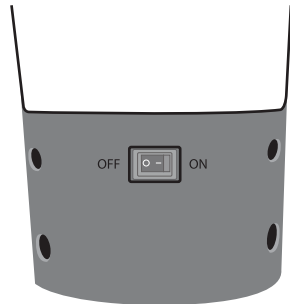







To Turn on the sprayer:

1. Turn on the sprayer using the ON/OFF switch. LED light will illuminate to indicate that the sprayer is ON.
2. When power switch is on, an audible motor sound will be heard. The Internal pump will operate continuously, solution will circulate through the pump and back in the tank (if any).
3. Place the lance with the trigger valve pressed above the base of the sprayer until the spray jet begins to spray continuously.
4. Direct the spray lance to a safe position and open the trigger valve to begin spraying.

To turn off the sprayer:

1. Shut off the trigger valve. The Internal pump will operate continuously, solution will circulate through the pump and back in the tank (if any).
2. Turn off the sprayer using the ON/OFF switch. LED light will turn off to indicate that the sprayer is OFF.
3. Direct the spraying lance to a safe position and open the trigger valve to release pressure before storing the sprayer.

6. Nozzle & Performance

Type	Sprayer Model	Pressure (psi/kg)	Mist setting output (ml/ min)	Steam setting output (ml/ min)	Coverage @ 3.3' height	Horizontal reach (Steam setting)
 Brass Cone (1.9mm Orifice)	100, 101, 103, 201, 202, 401, 402, YT10, YT20, YT30, 20C, 35C, PS20, 105E, 105Ex	40/2.8	1300	1950	3.6'x3.6'	33.4'
 Brass Cone (1.3mm Orifice)	YT25E	24/1.6	600	890	2.6'x2.6'	31'
 Black Cone (1.5mm Orifice)	301, 302, 403, 10ACID, 20ACID, FH10, FH20, FH30, BL20, 20ACT, 35ACT,	30/2.0	475	1000	3.2'x3.2'	36.7'
 Gray Cone (1.0mm Orifice)	BL25E, FH25E	24/1.6	370	650	2.2'x2.2'	31'
 Yellow Fan 90°	100, 101, 103, 201, 202, 301, 302, 401, 402, 403, 20C, 35C, 10ACID, 20ACID, 20ACT, 35ACT, BL20, PS20, YT10, YT20, YT30, FH10, FH20, FH30	40/2.8	1000	n/a	n/a	n/a
	BL25E, FH25E, YT25E	24/1.6	700	n/a	n/a	n/a
 Blue Fan 110°	100, 101, 103, 201, 202, 301, 302, 401, 402, 403, 20C, 35C, 10ACID, 20ACID, 20ACT, 35ACT, BL20, PS20, YT10, YT20, YT30, FH10, FH20, FH30	40/2.8	1150	n/a	n/a	n/a
	105E, 105Ex	30/2.0	1050	n/a	n/a	n/a
	BL25E, FH25E, YT25E	24/1.6	850	n/a	n/a	n/a
 Gray Fan 135°	105E, 105Ex	30/2.0	1650	n/a	n/a	n/a

7. Application

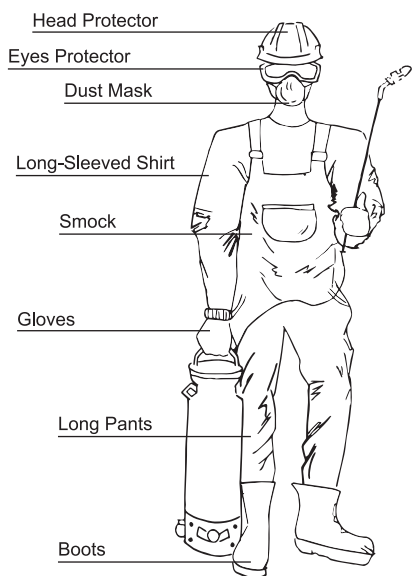

- **Protective equipments for handling chemicals is obligatory**



WARNING:

Use of individual protective clothing and safety equipment is required.



WARNING:

Use the correct dose and volume of chemical according to the product label.



WARNING:

Do not spray near people who are not using PPE, springs, lakes and rivers.



WARNING:

In case of an accident, remove the sprayer immediately.

8. Parts Breakdown

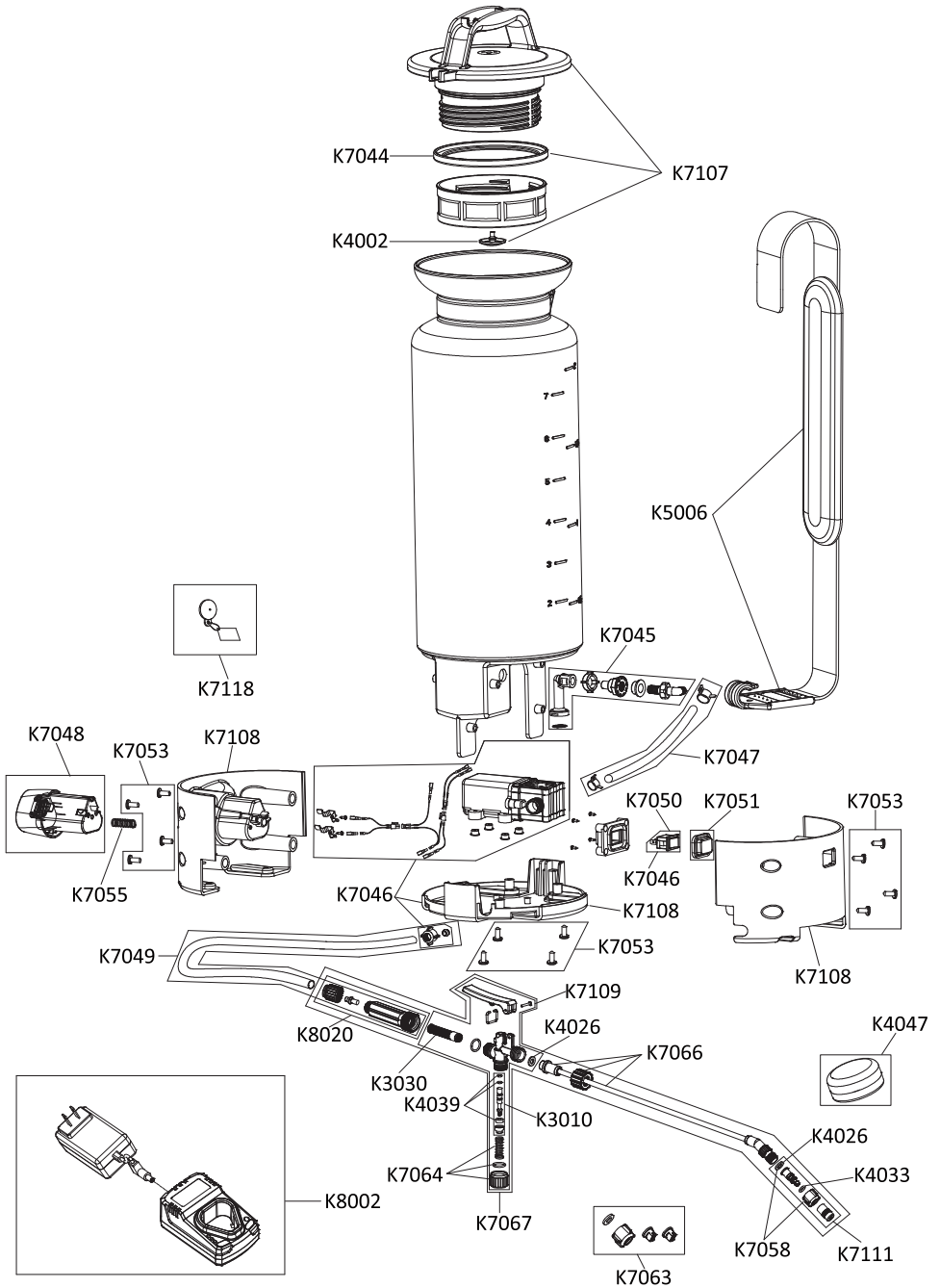

PART LIST

K3010	BRASS SPINDLE SET
K3030	SPRAY GUN FILTER
K4002	CHECK VALVE
K4026	WASHER SET FOR SPRAY GUN - VITON -
K4033	VITON O-RING FOR ADJUSTABLE NOZZLE
K4039	O-RING, & WASHER SET FOR SPINDLE
K4047	SILICONE GREASE
K5006	PADDED SHOULDER STRAP
K7044	LID SEAL
K7045	SCREEN FILTER TUBE SET
K7046	12V PUMP UNIT
K7047	CONNECTION HOSE SET FOR 12V PUMP
K7048	12v BATTERY PACK
K7049	HOSE SET W/CLAMPS
K7050	LED ON/OFF SWITCH
K7051	POWER SWITCH SEAL COVER
K7053	12 PCS SCREWS SET FOR BASE STRUCTURE
K7055	BATTERY EJECT SPRING
K7058	NOZZLE HOLDER
K7063	PLASTIC FAN NOZZLES SET
K7064	SPRAY GUN PLUG SET
K7066	20" BRASS SPRAY WAND
K7067	SPRAY GUN A5
K7107	LID SET - BLACK
K7108	BASE STRUCTURE SET
K7109	SPRAY GUN A PARTS
K7111	NOZZLE PARTS SET (BRASS)
K7118	ORANGE INSULATION COVERS
K8002	12V CHARGER & TRANSFORMER
K8020	NEW GRIP SET

9. Important Return Safety Instructions

If it is necessary to return the sprayer for repair, always perform the following tasks before returning the sprayer:

1. In an approved containment area, flush chemical residue from the pump, tank and hoses.
2. Circulate fresh water through the tank, pump and hoses.
3. Indicate the type of chemicals that have been in the sprayer with a label or tag.
4. Include complete description of operation problem, such as how sprayer was used, symptoms of malfunction, how many working hours per day, etc.
5. Remove the battery from the sprayer and keep it in clean and dry conditions. Battery must accompany the sprayer when it is returned for repairs.

Since the sprayer can contain residues of toxic chemicals, these steps are necessary to protect the people who handle return shipments, and to help identify issues and solutions.

10. Statement of Limited Warranty

Sprayers Plus shall warrant the equipment described in this manual and shall repair or replace parts and components which, under normal operation and wear, in accordance with technical recommendations, show DEFECTS IN MATERIAL OR WORKMANSHIP, based on the following conditions.

10.1 Warranty period

1 (one) year from the date of sale to the original purchaser.

10.2 Warranty Registration

Please visit: www.sprayers-plus.com/warranty

Sprayers Plus shall honor this warranty, free of charge, if any part or component shows defect in MATERIAL OR WORKMANSHIP, after final analysis at the factory.

10.3 This Warranty shall be null & void in case of:

- Misuse of the equipment against specifications in this manual, overwork or accidents.
- Preventive / remedial maintenance performed by unauthorized people or parties.
- Use of parts and components not supplied by Sprayers Plus.
- Modification of the equipment or any characteristic of the original design.

10.4 This Warranty shall exclude

- Parts which show wear and tear due to use: spray nozzle, filters, seals, rechargeable battery, hydraulic pump, electronic panel, charger and its cables, agitator lever, belt, UNLESS THEY SHOW DEFECTS IN WORKMANSHIP, ASSEMBLY OR MATERIAL.
- Damages resulting from accidents.
- Transportation or freight of the equipment, parts, and components in case such warranty is not approved.
- Transportation and travel time of technician.

11. Maintenance

11.1 Lubrication

To prolong the life and maintain good performance of the product, follow the lubrication point(s) and lubricates all moveable rubber pieces with silicone grease.

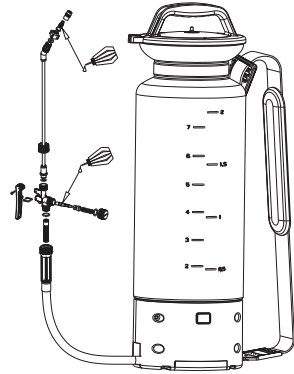

11.2 Clean and Wash

Follow the cleaning point(s) and clean your sprayer thoroughly after each use. Soap can be also added to the water for better cleaning result.

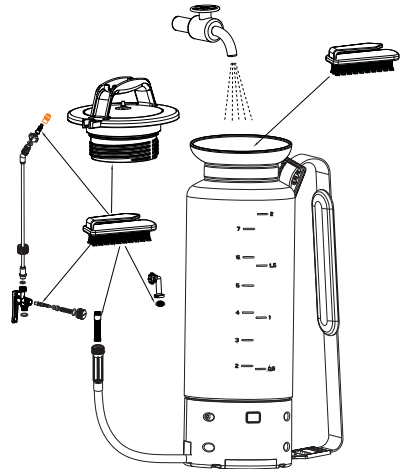

11.3 Long-term Storage

To ensure adequate moisture is retained for the pump during long-term storage (over two months), follow these steps:

1. Remove black screen filter from the water inlet.
2. Insert orange insulation plug to retain moisture.



- Orange insulation plug (Part #K7118)

12. Troubleshooting

If sprayer is not working as expected, consider the following table before contacting technical assistance.

Fault Status		Cause	Solution
Pump is working, but fluid is not coming out of the sprayer	Trigger valve is not released	Trigger valve is shut	Release trigger valve
	Trigger valve is released	Nozzle or nozzle filter is blocked	Clean or replace nozzle/filter
		Pump suction inside the chemical tank is blocked	Contact for technical assistance
		Suction hose is blocked or disconnected	
	Pump or hoses are leaking		
Pump is not working (no audible noise from pump) while sprayer is turned ON	Trigger valve is not released	Trigger valve is shut	Release trigger valve
	Trigger valve is released	Pump electrical connector is disconnected	Connect pump electrical connector
		Nozzle or nozzle filter is blocked	Clean or replace nozzle/filter
		Pump wiring is broken	Contact for technical assistance
		Pump is damaged	
		Battery is fully discharged	Recharge battery with Sprayers Plus charger
Battery is damaged and/or electronic module is damaged	Contact for technical assistance		
Spray pressure is weak	—	Air accumulation inside the lance	Place the lance with the trigger valve pressed above the base of the sprayer until the spray jet begins to spray continuously
		Pump suction inside the chemical tank is partially blocked	Remove obstruction and circulate clean water to clean the hoses
		Suction hose is partially blocked	Circulate clean water to clean hoses
		Pump or hoses are leaking	Contact for technical assistance
		Nozzle or nozzle filter is blocked or damaged	Clean or replace nozzle/filter
Spraying was normal but stopped suddenly	ON/OFF was pressed	Pump reached maximum pressure and pressure switch activated	Nozzle is plugged. Rinse with clean water.
	No audible noise when pumping	Pump wiring is loose, damaged or disconnected	Check pump wiring
Battery duration time is shorter than usual or battery failed to charge	New Battery	Battery is not fully charged	Charge the battery until indication light on the charger turns green
		Using third-party charger	Use Sprayers Plus certified charger
		Using third-party pump	Use Sprayers Plus certified pump
		Damaged cords/plugs on charger	Replace with new charger
	Used battery with more than 300 charge cycles	Battery has exceeded its optimal number of charge cycles	Replace with new battery



✉ E-mail: info@sprayers-plus.com
www.sprayers-plus.com